

Parts List and Assembly Diagram

Thank you for buying a quality above ground swimming pool from Wilbar!

We are providing you with this parts list and assembly diagram to assist you during installation and with the identification of parts should you ever need to order replacements. Use this sheet, along with the manual, to ensure proper location and assembly of all the parts of your pool.

Please read and understand this document completely before beginning the assembly of your pool. Also, make sure to save this sheet with your original purchase records. It contains vital information to assist us in identifying your pool should you ever need assistance.

Important Product Information

Description: 7000 Series Fusion 52"

Aliases: Ultima

Key Product Features:

- SunSafe™ Cellular High Density Resin Seats
- Z-BOLT Double-Track Wall Bolt Pattern
- ArmorCoat™ Wall with PolyTek™ Frame
- LiquiLok™ Epoxy Wall Backer

If your pool size is:

Your Complete Pool SKU # is:

12'x24'

FS07A-52W-1224

16'x24'

FS07A-52W-1624

16'x32'

FS07A-52W-1632

18'x34'

FS07A-52W-1834



WARNING! Shallow Water!

Absolutely NO DIVING or Jumping!

May cause Permanent injury or death.

Your pool is approximately 4 feet deep. It is not designed for jumping or diving. If you jump or dive into this pool, you run a high risk of permanent injury or death.

Make sure all pool users, including guests, are aware of this, and point out all warning labels!



7000 Series Buttress Oval RTS

Classic and Ultra

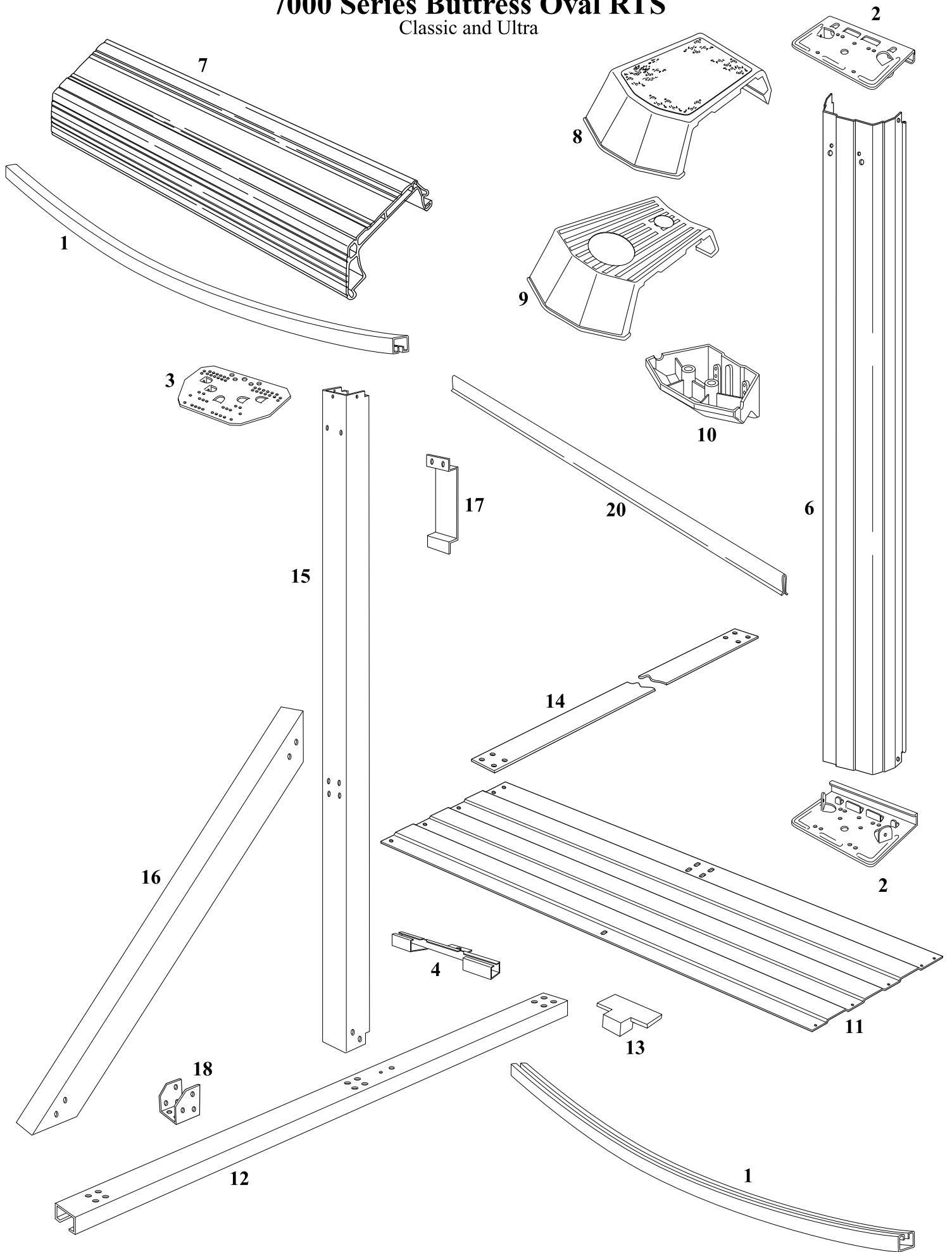

7000 Series Buttress Oval RTS

Classic and Ultra

Hardware is shown approximate actual size.

5 Fastener Pack

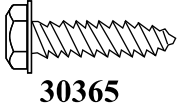

30365

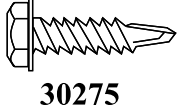

30275

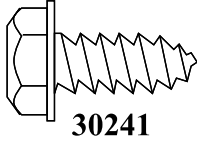

30241

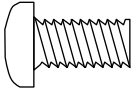

30246

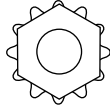

30256

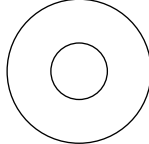

30257

21 Wall Bolt Pack (Ultra ONLY)

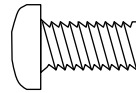

30246

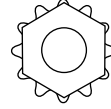

30256

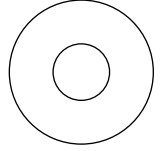

30257

19 Stainless Steel Panel (Ultra ONLY)

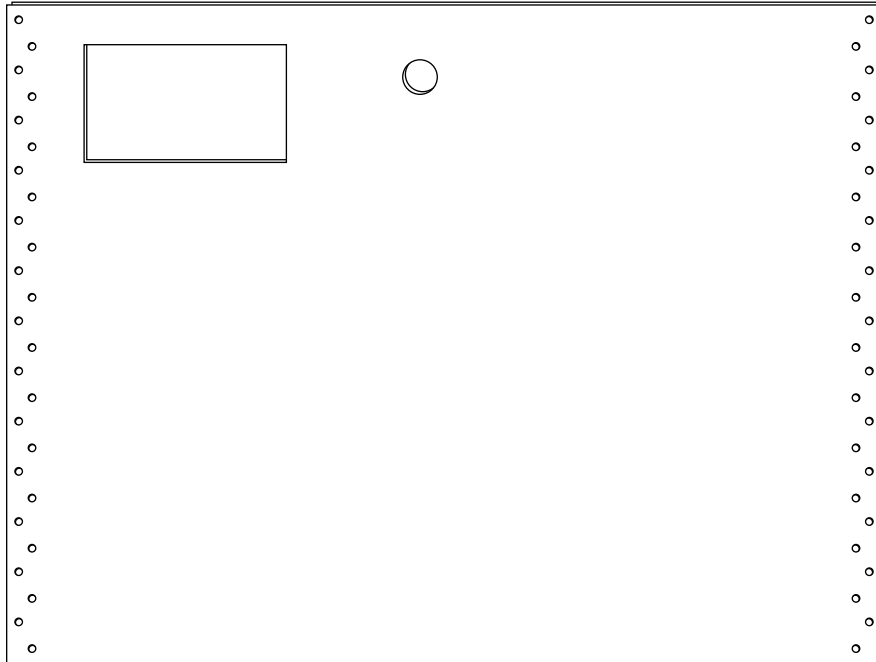

Product Family:	7000 Series 52" RTS	Rev Date:	11/30/2007
Style: FS07A-52W	Buttress Oval	Aliases: Fusion, Ultima	

Rim & Hdwr 7000			Carton Code: RH70-SSSS-BXXXX			
Description	Part Number	Length	1224'	1624'	1632'	1834'
1 Top & Btm Side Rims	56458-298-A4563	45 5/8"	8			
	56458-298-B4563	45 5/8"		4	12	
	56458-298-C4563	45 5/8"				12
1 Top & Btm End Rims	56458-298-A4669	46 11/16"	16			
	56458-298-B5181	51 13/16"		20	20	
	56458-298-C4919	49 3/16"				24
1 Top & Btm Transition Rims	56458-298-A4500	45"	8			
	56458-298-B4500	45"		8	8	
	56458-298-C4500	45"				8
2 Top & Bottom Plates	56202-000-00000	N/A	20	24	24	28
3 Oval Top Plate	53863-000-00000	N/A	6	4	8	8
4 5/8" Rim Adapter	33876-000-00000	N/A	12	8	16	16
5 Fastener Packages	64020-000-00000	N/A	1			
[These Part #s cover the entire fastener pack. Individ. parts are listed below.]	64021-000-00000	N/A		1		
	64022-000-00000	N/A			1	
	64023-000-00000	N/A				1
Fastener Pack Contents						
#10 3/4" Screw	30365-499-00000	N/A	64	64	80	88
#10 3/4" Self Tap Screw	30275-499-00000	N/A	154	142	198	214
Bolt 1/4-20 x 1/2"	30246-440-00000	N/A	123	99	147	147
Kep Nut 1/4-20	30256-440-00000	N/A	123	99	147	147
Washer	30257-440-00000	N/A	174	150	198	198
5/16" x 3/4" Hex Wash Screw	30241-440-00000	N/A	102	68	136	136

Uprt 7000 Grey			Carton Code: U70-GS52-XXXX			
Description	Part Number	Length	1224'	1624'	1632'	1834'
6 Uprights	56488-350-05175	51 3/4"	10	12	12	14

Seat & Clamp 7000 Grey			Carton Code: SC70-GRGR-XXXX			
Description	Part Number	Length	1224'	1624'	1632'	1834'
7 Seats - Resin	31648-350-04625	46 1/4"	16	6	10	10
	31648-350-05075	50 3/4"		10	10	
	31648-350-04950	49 1/2"				12
8 Resin Clamp Top (Straight)	31636-350-00000	N/A	6	16	20	22
9 Resin Clamp Top (Tapered)	31632-350-00000	N/A	10			
10 Resin Clamp Base	31633-350-00000	N/A	16	16	20	22

Base Buttress			Carton Code: XXXX-BASE-7H			
Description	Part Number	Length	1224'	1624'	1632'	1834'
11 HD Plates (Lipless)	33892-000-00000	N/A	6	4	8	8
12 Ground Channel	33874-000-00000	N/A	6	4	8	8
13 Foam Block Pad	49166-000-00000	N/A	6	4	8	8
14 Strap	56420-000-11538	115 3/8"	3			
Strap	56420-000-16338	163 3/8"		2	4	
	56420-000-18738	187 3/8"				4
Homeowners Package	69803-000-00000	N/A	1	1	1	1

Buttress 7000 Grey		Carton Code: B70-G52-XXXX					
	Description	Part Number	Length	1224'	1624'	1632'	1834'
15	Side Upright Buttress	56439-350-05181	51 13/16"	6	4	8	8
16	Diagonal Brace	56438-350-04216	42 5/32"	6	4	8	8
17	7H Spanner Bracket	33870-000-00000	N/A	6	4	8	8
18	Small Main Brackets	33864-000-00000	N/A	18	12	24	24

Fusion 52" 7000 Series Classic							
	Part Description	Part Number	Length	1224'	1624'	1632'	1834'
20	Wall 52" WM Skimmer Opening	122452-FUSN-LG	62' 5/8"	1			
		162452-FUSN-LG	66' 11 1/16"		1		
		163252-FUSN-LG	83' 1 1/16"			1	
		183452-FUSN-LG	89' 2 5/8"				1
	Coping Strips	33789-299-00000	48"	16	17	21	23